



Lexmark MS510 Series



More speed. Better results.

The Lexmark MS510 Series provides enterprise-worthy speed, reliability and convenience. Improve productivity and save time with fast print speeds up to 45 pages per minute.

Look professional. Work smart.

With our exceptional laser printers, it's easy to make a great impression on customers. Our system is simple to use, too, thanks to the easy-to-read control panel, eco-friendly supplies and more.

Fast set up: Instructions are easy. You'll be up and running in minutes.

High resolution graphics: With up to true 1200x1200 dpi resolution, images and graphics stay crisp. Lexmark's Unison™ Toner ensures consistent quality, too.

Control panel with number pad: Stay informed on your jobs with our easy-to-read 2.4-inch color LCD display.

Innovative toner that optimizes performance: Get greater system performance with Lexmark's Unison™ Toner, which delivers consistent image quality from first print to last.



Up to
32 ppm



Network



Big on productivity. Compact in design.

Designed to handle busy offices, our systems quickly produce high quality, professional prints in a space-saving design.

Print complex documents fast: Print documents containing graphics and images effortlessly with up to 1.2 GB of upgradable memory and a powerful 800 MHz dual-core processor.

Reliable performance: Busy workgroups can easily print up to 14,000 pages per month, plus enjoy fewer maintenance hassles, thanks to our state-of-the-art paper handling.

Run jobs without interruption: With an input capacity of up to 2,000 sheets plus ultra high yield toner cartridge options, you won't have to add paper or change cartridges as often.

Get work done quickly: Experience less wait time with print speeds up to 45 pages per minute—plus get your first page in as little as 6.5 seconds.

Get more work done effortlessly.

Quickly respond to changing business needs with our eco-friendly printers that help streamline your workflow using productivity solutions.

Help workers do more: With standard Gigabit Ethernet networking, our system can print jobs from the network faster, so your teams stay productive.

Enjoy enterprise-level security: Now you can authenticate, authorize and audit employee usage—plus protect sensitive data using standard network security protocols.

Save resources and the planet: An instant warm-up fuser, built-in two-sided printing, an ultra high yield toner option, plus Quiet, Hibernate and Eco modes minimize noise and save paper and energy.

Print anytime and anywhere: With this system, you can print from desktops as well as mobile devices that can run applications.

MS510 Series printer features

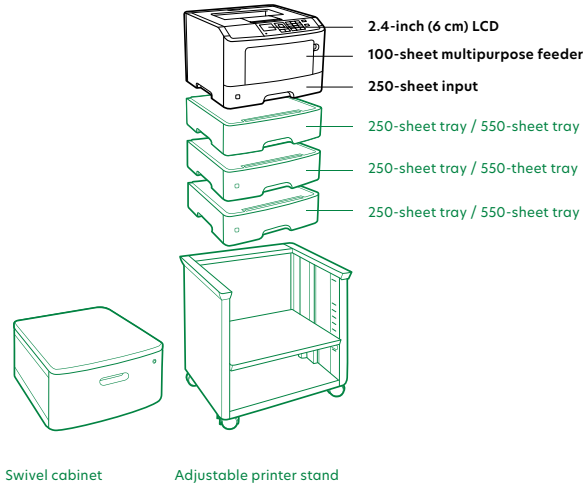

Product specifications	Lexmark MS510dn
Printing	
Display	2.4-inch (6 cm) color LCD display
Print speed: Up to ⁴	Black: 45 ppm
Time to first page: As fast as	Black: 6.5 seconds
Print resolution	Black: 600 x 600 dpi, 2400 Image Quality, 1200 Image Quality, 1200 x 1200 dpi
Memory / processor	Standard: 256 MB / Maximum: 1280 MB / Processor: Dual Core, 800 MHz
Hard disk	Not available
Recommended monthly page volume ³	1500 - 14000 pages
Maximum monthly duty cycle: Up to ²	100,000 pages per month
Supplies⁵	
Laser cartridge yields	20,000 ¹ -page Ultra High Yield Cartridge, 10,000 ¹ -page Extra High Yield Cartridge, 5,000 ¹ -page Black High Yield Cartridge, 1,500 ¹ -page Cartridge
Cartridge(s) shipping with product	6,000 ¹ -page Starter Return Program Toner Cartridge
Paper handling	
Included paper handling	Integrated duplex, 150-sheet output bin, 100-sheet multipurpose feeder, 250-sheet input
Optional paper handling	550-sheet tray, 250-sheet tray
Paper input capacity: Up to	Standard: 350 pages 20 lb or 75 gsm bond / Maximum: 2000 pages 20 lb or 75 gsm bond
Paper output capacity: Up to	Standard: 150 pages 20 lb or 75 gsm bond / Maximum: 150 pages 20 lb or 75 gsm bond
Media types supported	Refer to the Card Stock & Label Guide, Plain Paper, Envelopes, Card Stock, Paper Labels, Transparencies
Media sizes supported	A6, Oficio, Universal, Statement, Folio, DL Envelope, A4, 7 3/4 Envelope, 10 Envelope, 9 Envelope, A5, Executive, JIS-B5, Legal, Letter
General⁷	
Standard ports	Gigabit Ethernet (10/100/1000), USB 2.0 Specification Hi-Speed Certified (Type B)
Optional network ports / optional local ports	MarkNet N8352 802.11b/g/n Wireless
Noise level, operating	Printing: 55 dBA
Product warranty	1-Year Exchange Service, Next Business Day
Size (in. - H x W x D) / weight (lb.)	10.3 x 15.7 x 15.0 in. / 33.1 lb.

¹ Average continuous black or continuous composite CMY declared cartridge yield up to this number of standard pages in accordance with ISO/IEC 19798. ² "Maximum monthly duty cycle" is defined as the maximum number of pages a device could deliver in a month using a multishift operation. This metric provides a comparison of robustness in relation to other Lexmark printers and MFPs. ³ "Recommended monthly page volume" is a range of pages that helps customers evaluate Lexmark's product offerings based on the average number of pages customers plan to print on the device each month. Lexmark recommends that the number of pages per month be within the stated range for optimum device performance, based on factors including: supplies replacement intervals, paper loading intervals, speed, and typical customer usage. ⁴ Print and copy speeds measured in accordance with ISO/IEC 24734, excludes first set of test documents. For more information see: www.lexmark.com/ISOspeeds. ⁵ Product functions only with replacement cartridges designed for use in a specific geographical region. See www.lexmark.com/regions for more details. ⁶ For more information on Lexmark Mobile Solutions see: <http://www.lexmark.com/mobile> ⁷ Printers are sold subject to certain license/agreement conditions. See www.lexmark.com/printerlicense for details. ⁸ Duplex (2-sided printing) models are ENERGY STAR[®] compliant.